

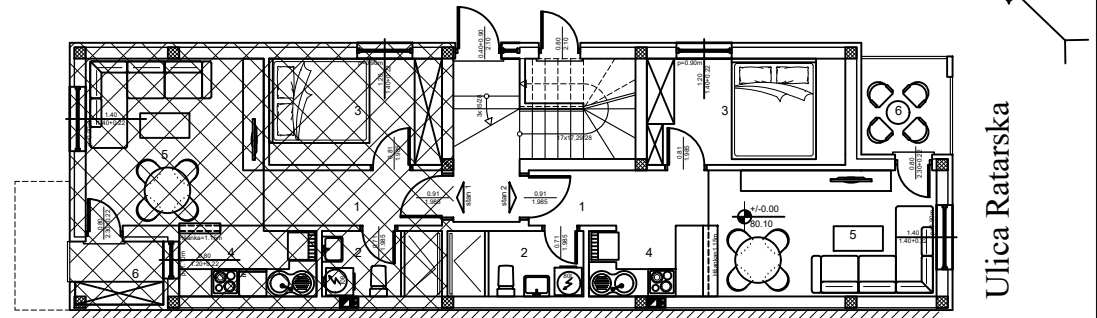

OSNOVA PRIZEMLJA / položaj stana u zgradi



FST INVEST DOO

STAMBENI OBJEKAT P+1+Pk

Ulica Ratarska bb, Novi Sad

K.P. 4844, K.O. Veternik

OSNOVA STANA BR. 1, P=37,71 m²

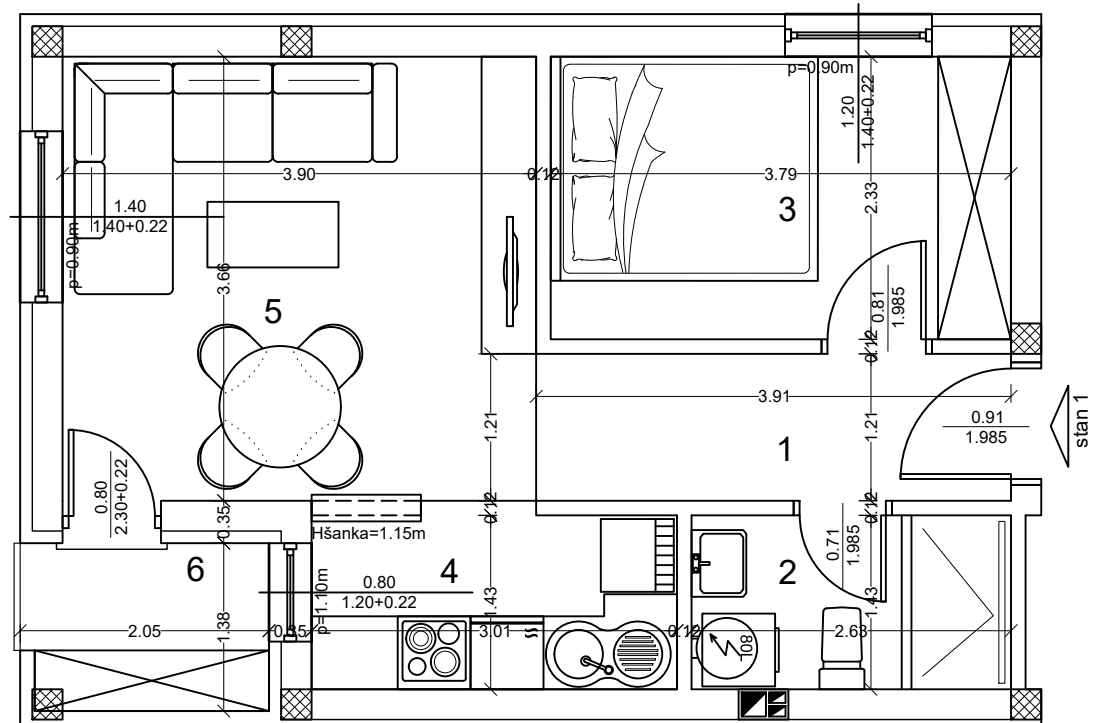

PRIZEMLJE - STAN 1

BR.	NAZIV PROSTORIJE:	P [m ²]
1.	Ulaz	4,59
2.	Kupatilo	3,66
3.	Spavaća soba	8,56
4.	Kuhinja	4,39
5.	Dnevna soba i trpezarija	13,83
6.	Terasa	2,69
	UKUPNO:	37,71



OSNOVA PRIZEMLJA / položaj stana u zgradi

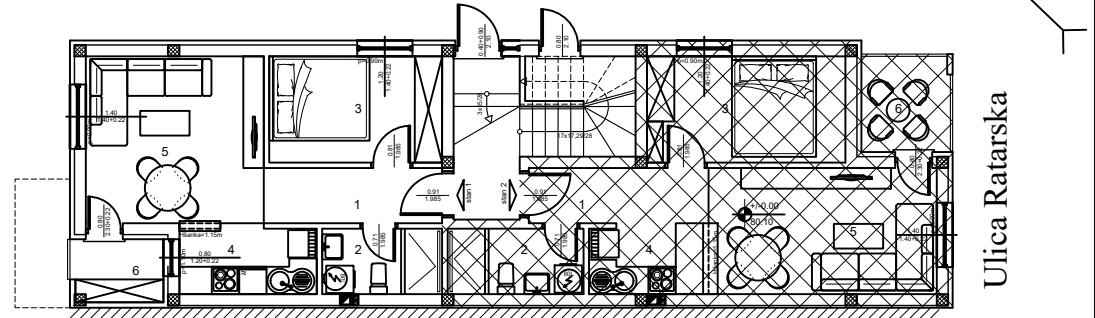

FST INVEST DOO

STAMBENI OBJEKAT P+1+Pk

Ulica Ratarska bb, Novi Sad

K.P. 4844, K.O. Veternik

OSNOVA STANA BR. 2, P=39,62 m²

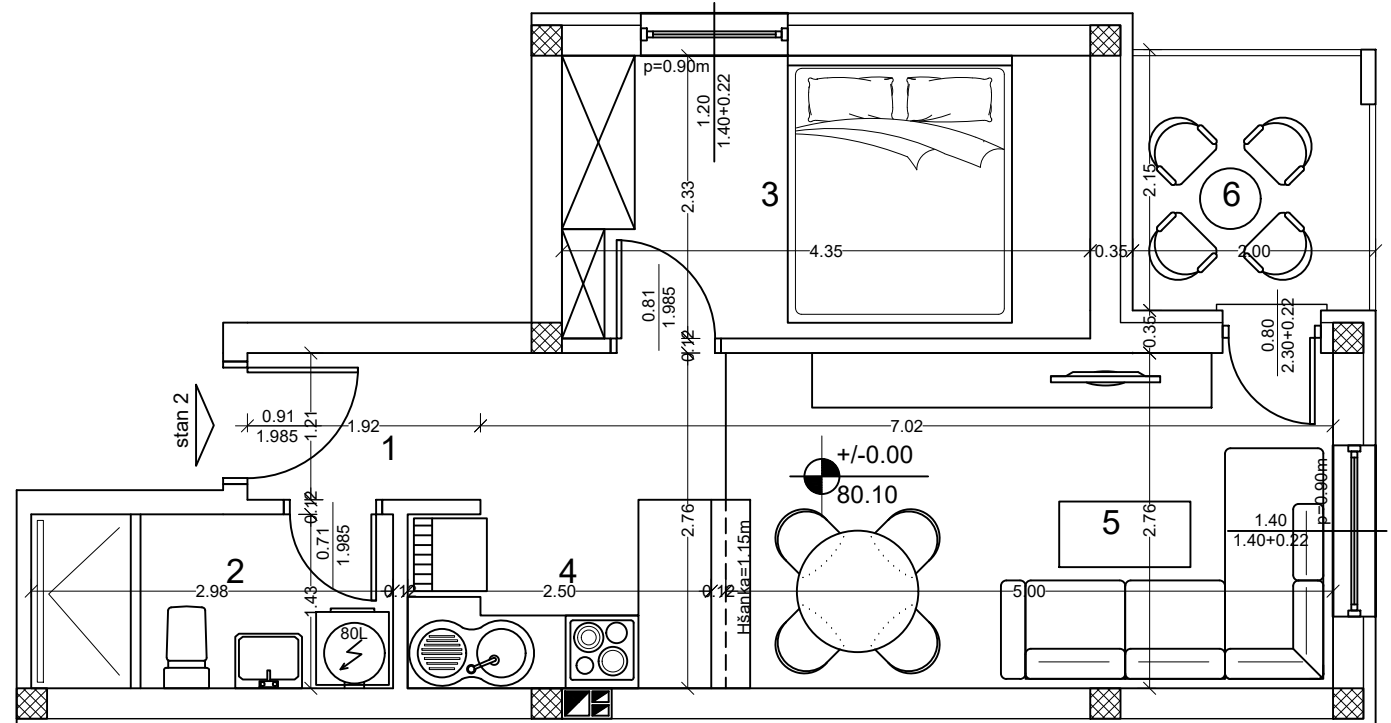

PRIZEMLJE - STAN 2

BR.	NAZIV PROSTORIJE:	P [m ²]
1.	Ulaz	4,63
2.	Kupatilo	4,14
3.	Spavaća soba	9,83
4.	Kuhinja	3,70
5.	Dnevna soba i trpezarija	13,40
6.	Terasa	3,94
	UKUPNO:	39,62



OSNOVA 1. SPRATA / položaj stana u zgradi

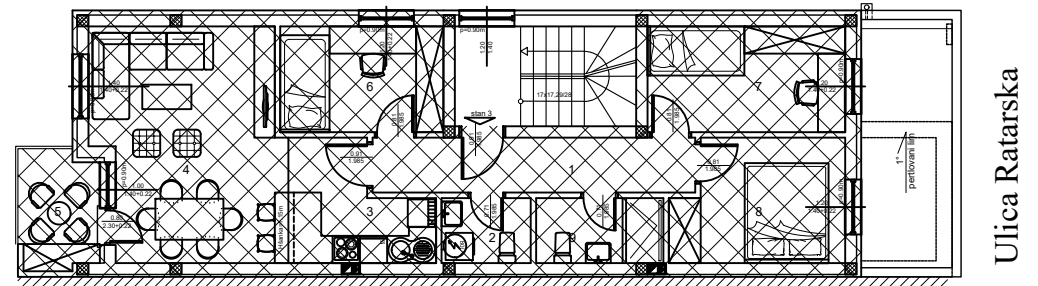

FST INVEST DOO

STAMBENI OBJEKAT P+1+Pk

Ulica Ratarska bb, Novi Sad

K.P. 4844, K.O. Veternik

OSNOVA STANA BR. 3, P=73,33 m²

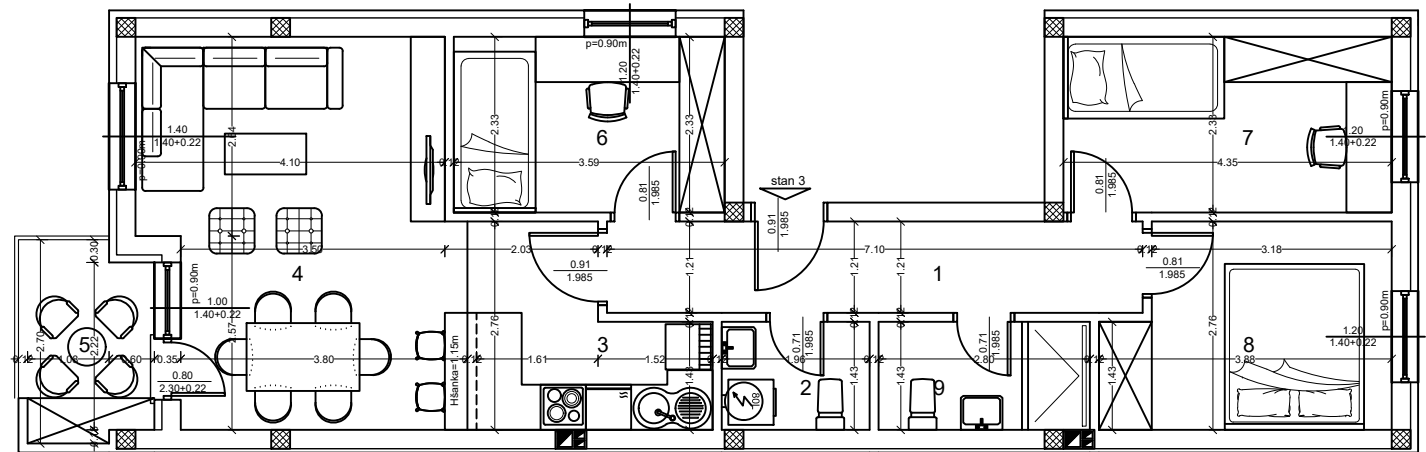

1. SPRAT- STAN 3

BR.	NAZIV PROSTORIJE:	P [m ²]
1.	Ulaz	8,33
2.	Toalet	2,73
3.	Kuhinja	6,57
4.	Dnevna soba i trpezarija	20,03
5.	Balkon	4,37
6.	Spavaća soba	8,10
7.	Spavaća soba	9,83
8.	Spavaća soba	9,50
9.	Kupatilo	3,89
	UKUPNO:	73,33



OSNOVA POTKROVLJA / položaj stana u zgradi

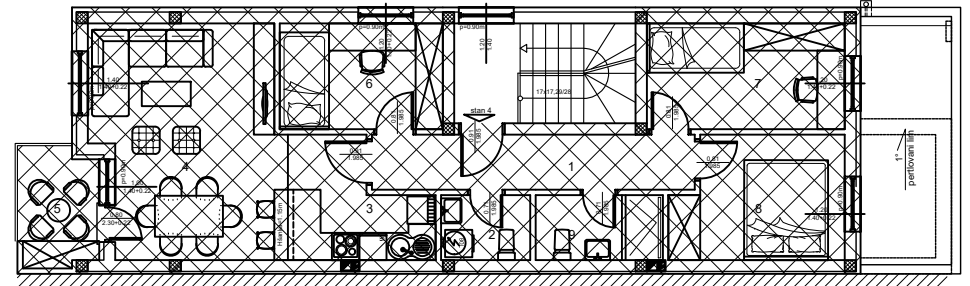

Ulica Ratarska

FST INVEST DOO

STAMBENI OBJEKAT P+1+Pk

Ulica Ratarska bb, Novi Sad

K.P. 4844, K.O. Veternik

OSNOVA STANA BR. 4, P=73,33 m²

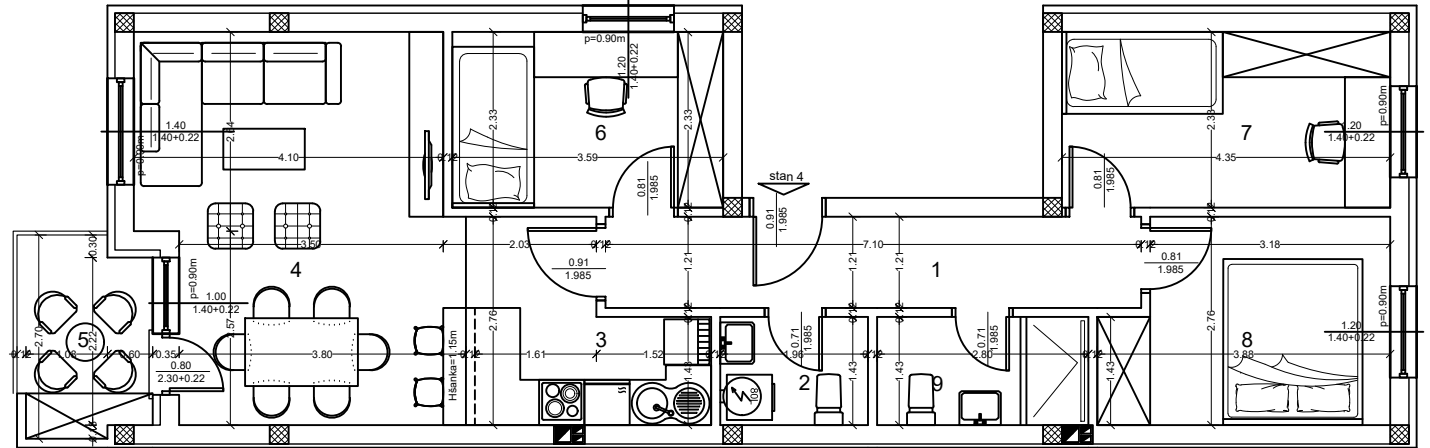

POTKROVLJE- STAN 4

BR.	NAZIV PROSTORIJE:	P [m ²]
1.	Ulaz	8,33
2.	Toalet	2,73
3.	Kuhinja	6,57
4.	Dnevna soba i trpezarija	20,03
5.	Balkon	4,37
6.	Spavaća soba	8,10
7.	Spavaća soba	9,83
8.	Spavaća soba	9,50
9.	Kupatilo	3,89
	UKUPNO:	73,33